



Reference Jubilee

User manual



Pic. similar

User manual

Dear **Clearaudio** customer,

Many thanks for choosing **Clearaudio's Reference Jubilee** turntable, a high quality product made in Germany by **Clearaudio Electronic GmbH**.

This limited edition turntable, created to mark the occasion of the company's 40th anniversary, combines a raft of design highlights from recent decades with some exciting new technical developments.

Please read this instruction manual carefully to avoid any potential damage or loss of warranty.

The manual will help to ensure an easy setup, and enable the greatest listening pleasure for years to come.

Thank you for your confidence in us and we hope you enjoy your new **Clearaudio Reference Jubilee** turntable.

Clearaudio Electronic GmbH

This section must be read before any connection is made to the mains supply.



Safety instructions

1. General information

Check the turntable for any damage before using it. Do not connect the turntable if damaged!

Never connect the turntable if it has been dropped or gotten wet, contact your dealer to have the turntable checked.

Never expose the turntable to rain or moisture.

Never touch the power cord of the device with wet hands.

Regular visual inspections for defective insulation on the connection cable are also recommended for your own safety. A damaged cable should be replaced immediately by a specialist!

Never pull on the power cord to unplug the device. Always pull directly on the plug!

The inside of the turntable is maintenance free. Never open the case or attempt to repair the unit yourself, since this can lead to loss of warranty!

We recommend disconnecting the power supply from the mains if you do not operate the device for a longer period of time.

The turntable does not feature an automatic shut-off mechanism.

Therefore, as soon as the stylus has reached the run-out groove, engage the tonearm lift and switch the turntable off.

Not suitable for children! Scope of delivery may contain small parts that can be swallowed.

2. Intended use

The *Reference Jubilee* is a turntable for playing records.

The intended use of the *Reference Jubilee* in accordance with the information provided in the user manual only.

The power supply may only be operated with maximum permissible connection values according to the technical data. Any other use or modification of this product is not intended.

3. Location of installation

Avoid locations with direct sunlight, temperature fluctuations and high humidity.

Likewise, avoid placing electronic devices near heaters, heat lamps, or other devices that produce heat.

The device is designed for operation at room temperature.

No objects with an open flame may be placed on or near the device (burning candles or similar).

4. Overload

The product is designed to comply with all necessary safety regulations. However, you should not leave the device unattended under extreme loads.

5. Maintenance

Never use aggressive cleaning detergent.

Do not use dry cloths for cleaning as this generates static electricity. Suitable cleaning and care products from **Clearaudio** are available from www.analogshop.de or from specialist retailers.

The bearing of the turntable platter can be lubricated every 2 years with the oil provided.

Put 1 or 2 drops of the oil into the bearing for lubrication.

6. Health information

Permanently high volume can lead to various types of hearing damage. Use high volume responsibly!

7. Service

The *Reference Jubilee* turntable should be repaired during the guarantee period by the manufacturer only, otherwise the warranty claim expires. All **Clearaudio** products should only be serviced by specialist retailers.

If, despite the high production standard, a service is necessary, the *Reference Jubilee* turntable must be send to **Clearaudio** through your dealer.

8. Transport

Use the original packing material for further transportation of the *Reference Jubilee* turntable, otherwise serious damage could occur.

Be sure to pack the device exactly as it was shipped.
Safe transport is only guaranteed in the original packaging.

Proceed in reverse as described for assembly when packing.

Always remove the turntable platter and replace the foam securing the sub-platter and cover the bearing with tape as well. Otherwise serious damage can occur.

Remove also the pulley from the motor axle to avoid any damage during transport.

Clearaudio assumes no liability for any damage that may occur due to incorrect packing.

9. Disposal



Do not dispose this product together with other waste.
WEEE Reg. No.: DE26004446

10. CE Marking



This electronic product corresponds to the applicable guidelines for obtaining the CE mark.



Contents

1. Package contents overview	6
2. List of components	7 - 8
3. Set-up	9 - 14
4. Mounting of tonearm and cartridge	15
5. Initial operation and calibration of the speed	16 - 17
6. Troubleshooting	18 - 19
7. Technical data	20
Warranty information	21 - 22

1. Package contents overview

Clearaudio has developed a special, secure packing for your *Reference Jubilee* turntable to ensure a safe transportation.

Please keep this original packing, if you need to ship the turntable.

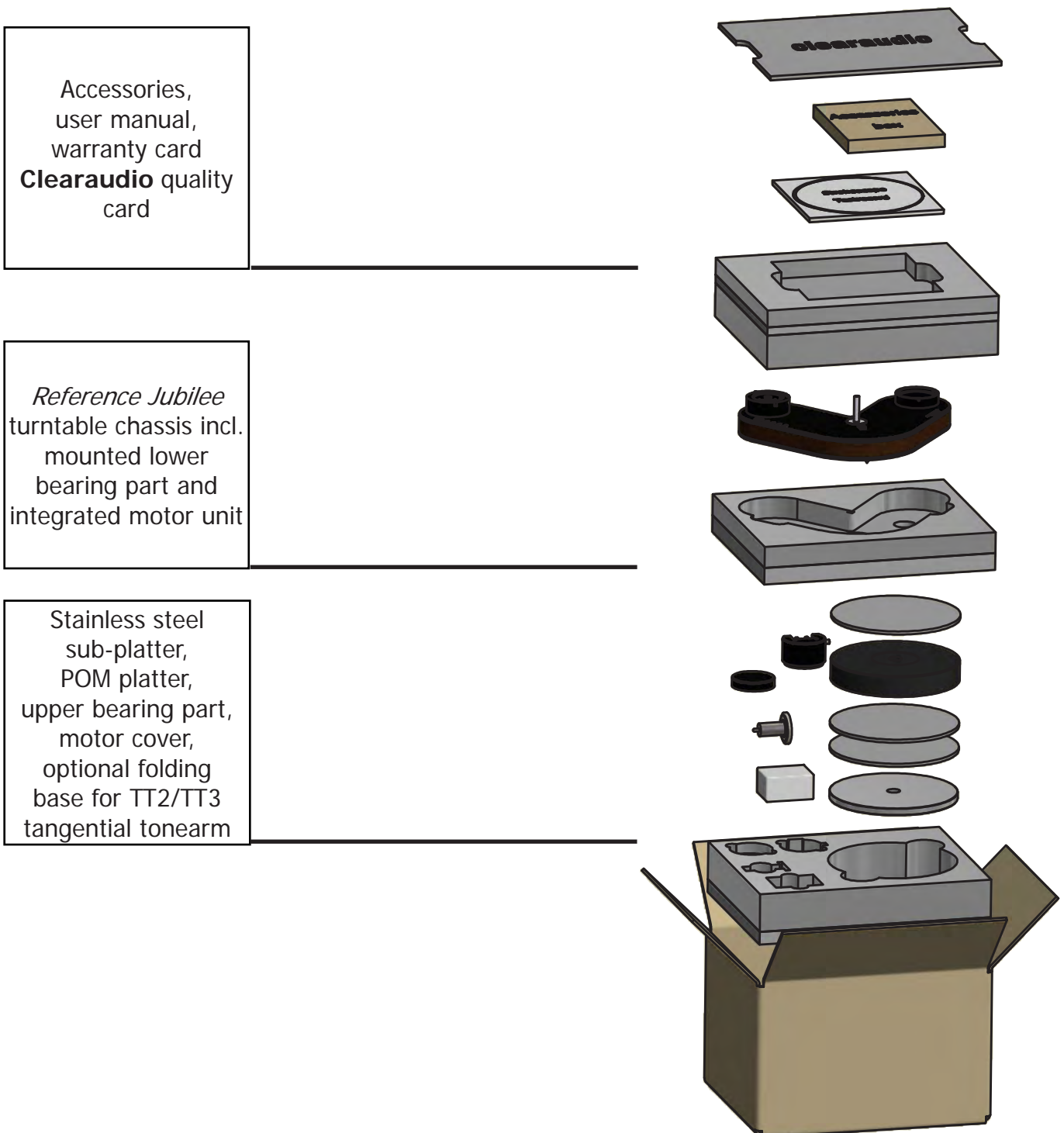

Pic. 1: Package contents overview

2. List of components

Please use the list below to check that all components of your newly purchased **Clearaudio Reference Jubilee** turntable have been correctly supplied.

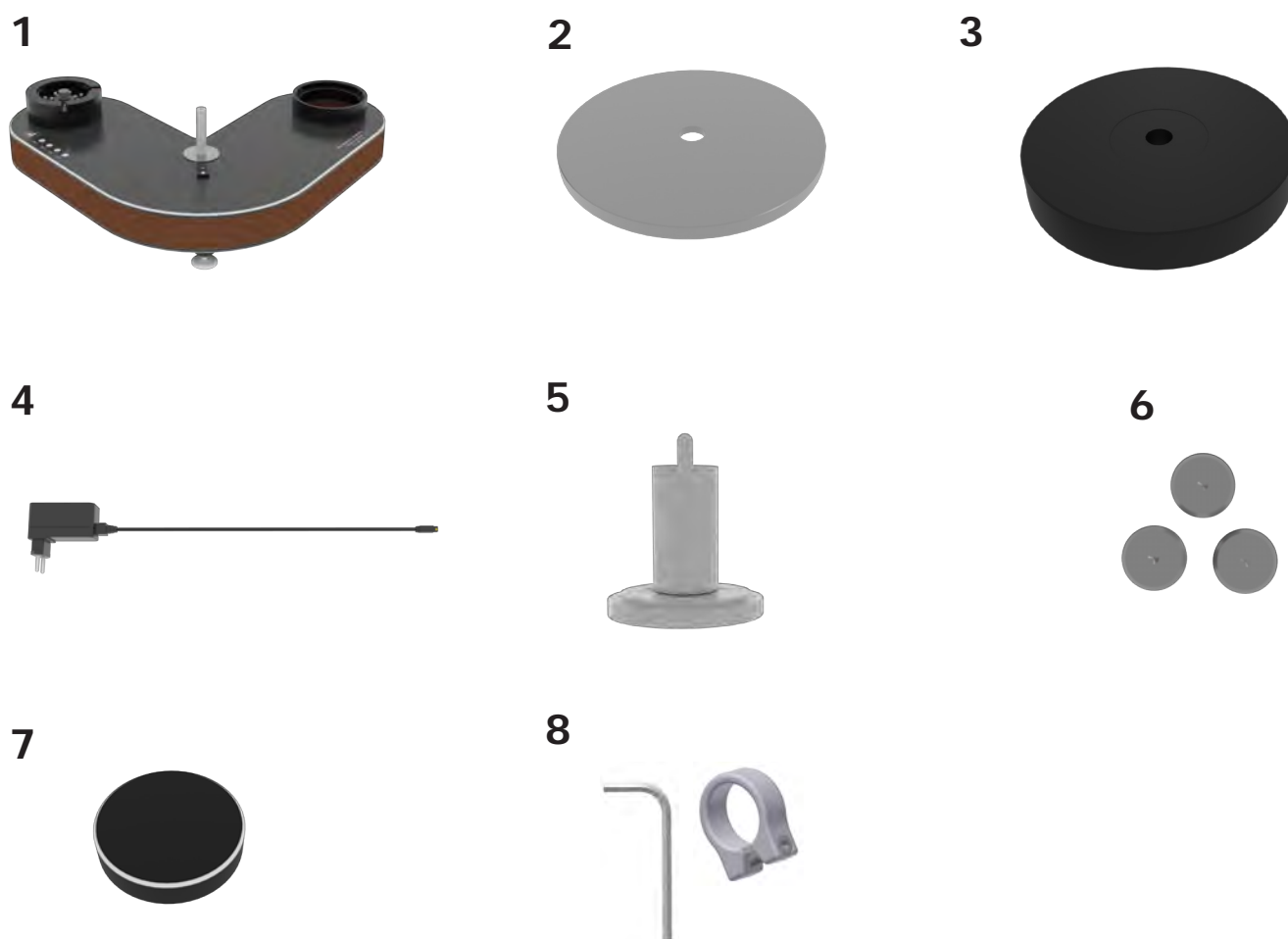

Pic. 2: List of components

1.	Turntable chassis with incl. lower bearing part	5.	Magnet bearing (upper part)
2.	Stainless steel sub-platter	6.	3x flat pad
3.	POM turntable platter	7.	Motor cover
4.	Power supply	8.	Mounting clip for stainless steel sub-platter and hex wrench

Components list (continued)

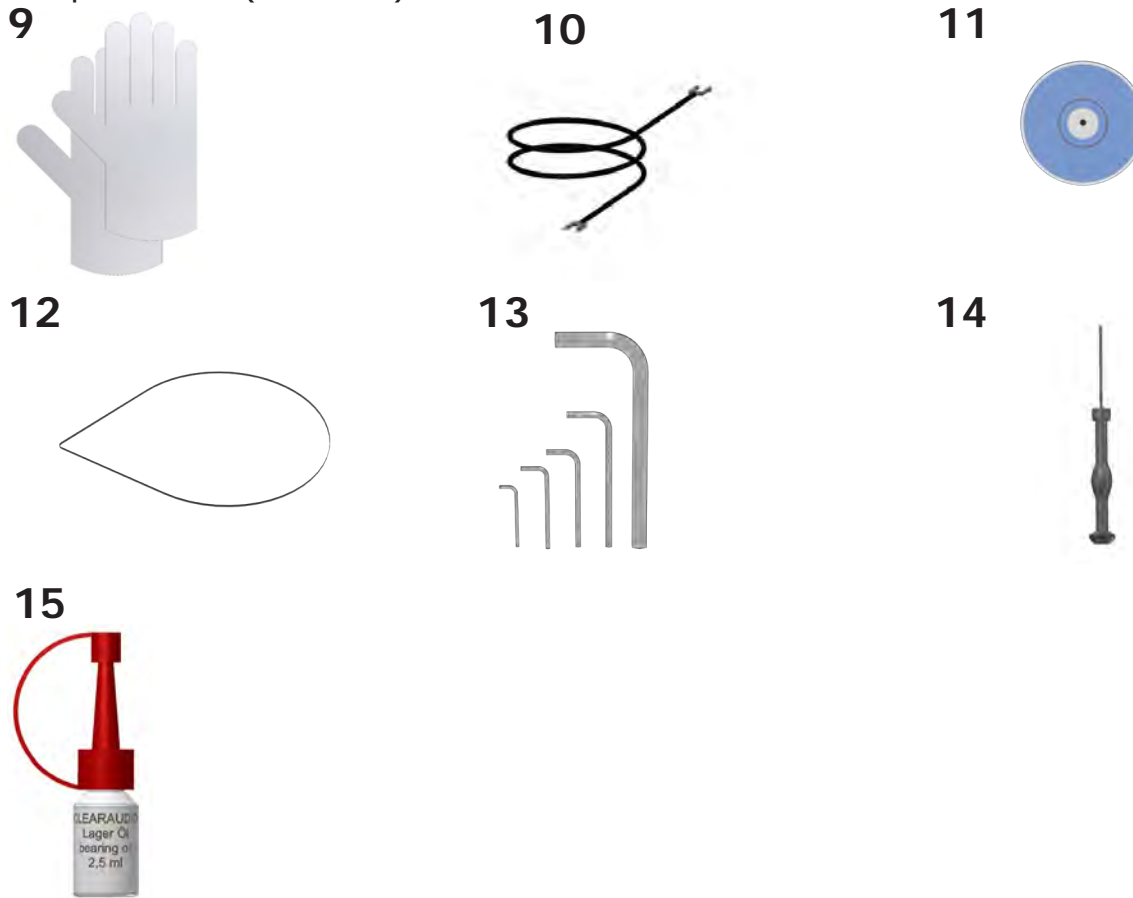

Pic. 2.1: List of components (continued)

9.	1 pair of white gloves	14.	Screwdriver
10.	Grounding wire for the turntable	15.	Bearing oil for occasional use
11.	Level gauge for turntable alignment	16.	Not shown: Tonearm base (depending on the tonearm ordered, this may be included in delivery or pre-mounted)
12.	1x flat belt	17.	Not shown: Warranty card, Clearaudio quality card, return delivery note
13.	5x hex wrench Sizes 1.5; 2; 2.5; 3; 7	18.	Not shown: User manual

IMPORTANT NOTICE:

Please double check the tightness of all bolts, hardware and mounting pods, as temperature fluctuations during transit may have caused the hardware to become loose.

3. Set-up

The set-up of the *Reference Jubilee* turntable is easy as the turntable chassis is pre-assembled and has been tested at the factory.

Please use the white gloves enclosed in order to avoid scratches or unwanted fingerprints (platter).

The *Reference Jubilee* turntable requires a space for setup of at least 495 x 343mm (19.49 inch x 13.50 inch).

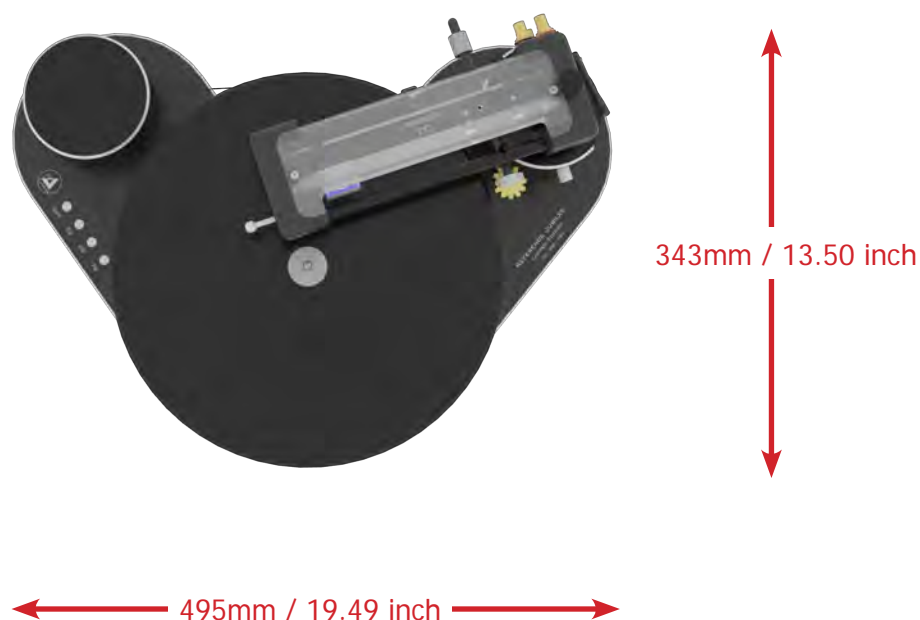

Pic. 3: Required set-up space *Reference Jubilee*

Please follow the instructions step by step:

3.1)

The top packaging level contains all accessoires. Please take out the three black flat pads. Place these flat pads on your hifi-rack or another suitable base, where the final position of your *Reference Jubilee* turntable will be.

3.2)

Remove the entire upper packaging level from the box. Take out the *Reference Jubilee* turntable body and place its pre-assembled feet (spikes) on the previously positioned flat pads.



Pic. 4: *Reference Jubilee* delivery condition

3.3)

To avoid hum noises we recommend to ground the bearing. To do so, attach the grounding wire supplied to the bearing cap with the screw provided.

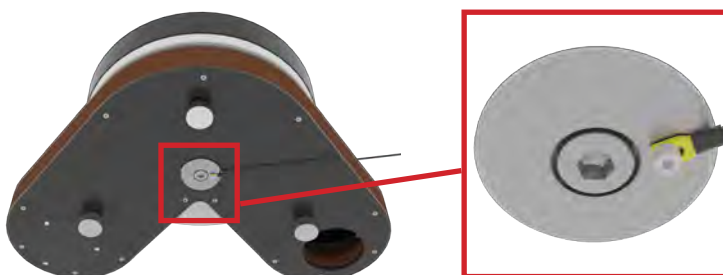

Pic. 5: Grounding the *Reference Jubilee*

3.4)

Remove the protective security tape from the bearing housing. Place two drops of the synthetic bearing oil on the ceramic bearing shaft (also available at www.analogshop.de, Art. No. AC068).



Pic. 6: Oiling the bearing shaft

User manual

3.5

Remove the protective film from the sensor mounted in the turntable chassis.

Please remove the protective film extreme carefully and avoid any soiling and scratches.

3.6.

Using both hands, carefully take the stainless steel sub-platter out of the box.

Carefully remove the protective film from the sensor ring on the underside of the sub-platter.

Again, please remove the protective film extremely carefully to avoid any soiling or scratches.

Carefully slide the upper part of the bearing through the opening of the sub-platter and fix the upper part of the bearing using the mounting clip supplied. The lower side of the platter with the sensor ring must point downwards.

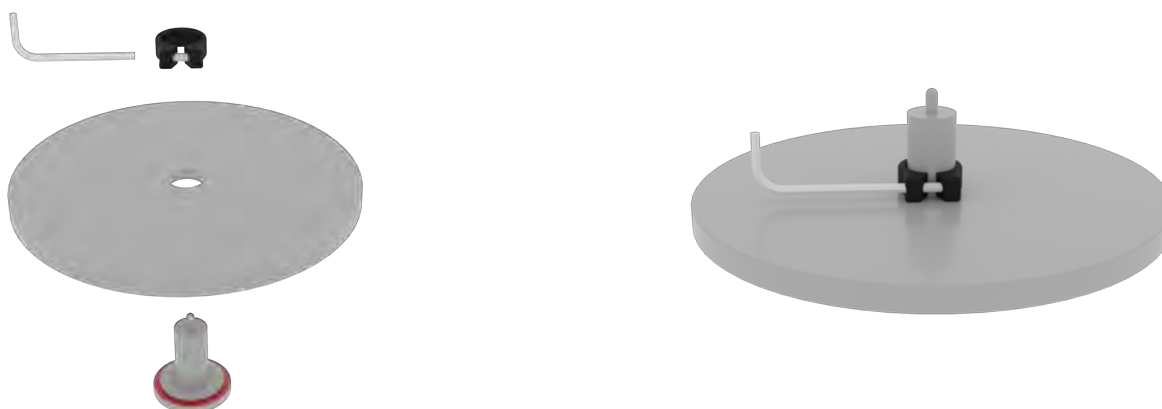

Pic. 7: Connection of sub-platter and bearing

3.7)

Place the sub-platter carefully and slowly on the axis of the pre-mounted magnet bearing on the turntable chassis.

Please proceed very carefully!

Make sure that the platter is positioned straight and level, so that it does not tilt and damage the bearing while it is being placed!

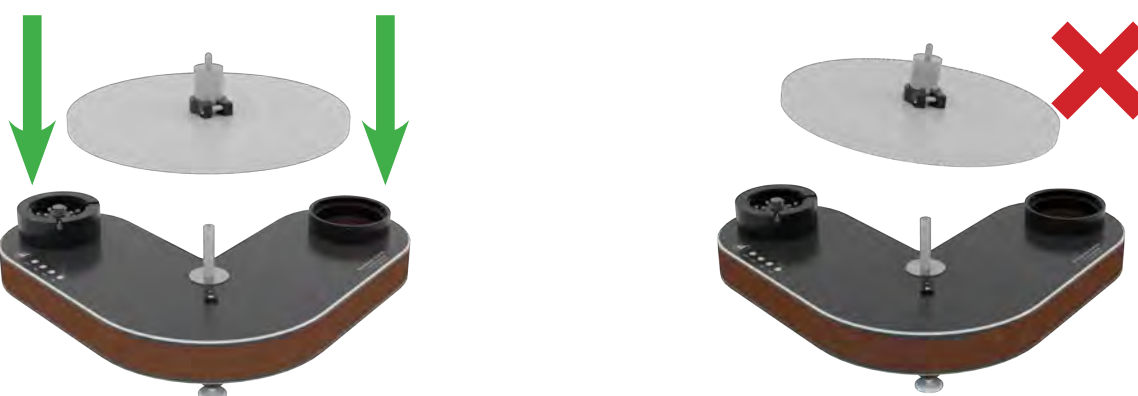

Pic. 8: Placing the stainless steel sub-platter

3.8)

Now you can remove the mounting clip with the hex wrench provided.



Pic. 9: Removing the mounting clip

3.9)

Take the second platter (made of POM) out of the packaging and slide it onto the bearing. The larger recess (for the record label) on the platter should point upwards.

Please ensure that the platter is at least room temperature (approx. 20°C) while mounting to avoid any damage to the bearing.

Avoid major side forces to avoid any damages to the ceramic bearing!



Pic. 10: Mounting the POM platter

3.10)

Place the flat belt around the platter and the motor pulley.

Make sure that the belt runs in the cutouts of the motor housing.

To ensure that the belt does not come off when it is started up for the first time, we recommend holding the flat belt in position with your finger and turning the platter by hand until the belt remains in the correct position.



Pic. 11: Mounting the belt

Close the motor unit with the supplied motor cover.
Make sure that magnets are on top of each other.



Pic. 12: Placing the motor cover

3.11)

The following final adjustment is very important:

Please check, using the bubble level gauge, that your *Reference Jubilee* turntable is in a level position. You can adjust each of the turntable's feet to achieve this.

You will only get the best results with your *Reference Jubilee* turntable if it is in a level position.



Pic. 13 a: Alignment of the turntable



Pic. 13 b: Adjustment of the turntable feet

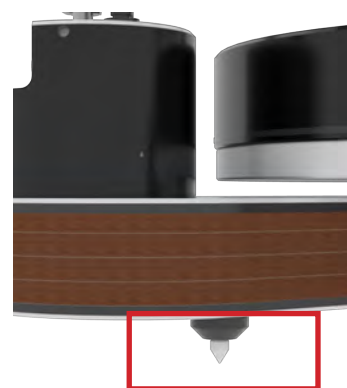

3.12)

Please connect the mains plug to your power supply.



Pic. 14: Connection power supply and motor

4. Mounting of tonearm and cartridge

4.1)

When ordering the *Reference Jubilee* turntable in combination with a **Clearaudio** radial tonearm, the required tonearm base is already pre-assembled. For final assembly and adjustment of the tonearm base and tonearm, proceed as described in the tonearm user manual.

4.2)

When ordering the *Reference Jubilee* turntable in combination with a **Clearaudio** tangential tonearm, you will find the required folding base in the bottom packaging layer.

Place the folding base on the opening provided, making sure that the cut-out points outwards. Then fix the three grub screws of the tonearm base mount to continue the tonearm mounting.



Pic. 15: Mounting the folding base

For the final assembly and adjustment of the tonearm, proceed as described in the relevant tonearm user manual.

Please note that you will need to slightly loosen the grub screws of the tonearm base mount for setting the tangential alignment (TT2 / TT3 user manual, point 7.3).

4.3)

For mounting and adjustment of the cartridge, please proceed as described in the relevant cartridge user manual.

Clearaudio offers a selection of professional setting tools for your turntable. Please contact your dealer / distributor for more information.

5. Initial start and calibration of the speed

5.1)

To start operating the turntable at the desired speed, press the relevant labelled button on the motor housing.

We recommend letting the turntable run-in for about 15-30 minutes when using it for the first time.



Pic. 16: Control panel *Reference Jubilee*

5.2)

Thanks to the newly developed motor control, the *Reference Jubilee* turntable calibrates itself automatically in order to always maintain the perfect speed.

However, manual calibration is also possible. We recommend this if the turntable has not been in use for a long time, if parts (e.g. the belt) have been replaced, or if the turntable is set up again after moving.

If you would like to start the calibration manually, please proceed as follows to recalibrate all three speeds. This process takes about 5 minutes.

Hold down the OFF button until the 33 button flashes and the platter begins to turn.

> The speed 33rpm is now calibrating.

When the 33 button lights up continuously and the 45 button starts to flash.

> The 33rpm speed is calibrated and the turntable is now calibrating 45rpm.

When the 45 button lights up continuously and the 78 button starts to flash.

> The 45rpm speed is calibrated and the turntable is now calibrating 78rpm.

The calibration for 78rpm is complete when all 3 speed options and the OFF button flash alternately.

A longer press on OFF (speed options stop flashing) saves the calibration of all three speeds.

To stop the calibration process you can press any button.

**5.3)**

In order to adapt the standard speed to your own preferences, you can also adjust the basic speeds manually.

To adjust the speed for example for 33 1/3rpm, hold down the button for 33 until it flashes.

The remaining buttons now function as + and - to gradually reduce or increase the speed. The respective key assignment can be found in the table below.

Speed	-	+
33 1/3rpm	45rpm	78rpm
45rpm	33 1/3rpm	78rpm
78rpm	33 1/3rpm	45rpm

If you want to reset this setting, proceed as described in point 5.2.

5. Troubleshooting

If you have a problem with your *Reference Jubilee* turntable, first check the possible causes to rule out incorrect operation.

If the error persists, please contact your dealer!

Never try to open the device and/or repair it yourself, this will void the warranty!

Error	Cause	Measure
Device does not work	Is the power cord plugged in?	Check the connection.
No sound	The tonearm and phono stage are not properly connected.	Check the cable connection between the tonearm and the phono stage.
	Is the amp turned on?	Check the power supply to the amplifier.
	The volume on the amplifier/ loudspeaker is set too low or on „mute“.	Check the volume settings.
	Is the cartridge protective cap still attached?	Remove the cartridge's protective cap.
	Is the tonearm in the raised position?	Lower the tonearm into the lead-in groove.
	Is the stylus damaged?	Check the stylus and have the cartridge checked by a specialist if necessary.
Bad sound / noise	Is the record or the stylus dirty or damaged?	Clean the record / or the cartridge. Clearaudio offers many helpful accessories for care and cleaning. In the event of damage, we recommend an assessment by a specialist and, if necessary, an exchange.
	Is the cartridge properly mounted into the tonearm?	Check the installation using the relevant user manual and correct them if necessary.
	Has the tracking force been set too high?	Adjust the tracking force.
	Is the correct operating mode (MM / MC) set on the amplifier?	Check the settings of your phono stage.
	The pre/amp does not have enough gain.	Check the settings of your phono stage.
	Pre/amp is mismatched.	Swap the plugs of the turntable that are connected to the left and right outputs.



Needle bounces or slides across record	Is the record or the stylus dirty or damaged?	Clean the record / or the cartridge. Clearaudio offers many helpful accessories for care and cleaning. In the event of damage, we recommend an assessment by a specialist and, if necessary, an exchange.
	Has the tracking force been set too high?	Adjust the tracking force.
	Is the record deformed or scratched?	Use a record clamp or replace the record.
	Is the turntable level?	Check the alignment of the turntable and adjust if necessary.
Platter does not turn	Is the drive belt properly attached?	Check the position of the drive belt.
	Is the power cord connected properly?	Check the connection.
	No speed was selected / speed selection in position „0“/“OFF“.	Select a speed and start the turntable.
Noisy sound	Is the drive belt properly attached?	Check the position of the drive belt. Is it too loose and needs to be changed?
Humming noises	Contact problems with the signal connections (e.g. cinch plugs, adapters for extensions)	Check all connections; reduce the level on the (pre-)amplifier to a low volume for acoustic checking of gross errors.
	Metal housing acts as an antenna and catches hum.	It can be helpful for conductivity to connect the metal parts of the turntable to the ground of the (phono) preamplifier. The turntable provides a grounding terminal for this purpose. Use a sufficiently thick wire to establish the ground connection.
	The pickup pins are mixed up, not connected correctly or defective.	Check the pin assignment of the pickup.
The music doesn't sound like usual	Wrong speed selected.	Check the record for recommended speed. There are also records in LP format (30 cm) that have to be played at 45 rpm ("maxi singles") and small records in single format (17 cm) that have to be played at 33 rpm (so-called "EP's").
	The turntable is spinning too fast/too slow.	Adjust the speed according to the operating instructions.

7. Technical data

Construction details:	<ul style="list-style-type: none"> • Resonance-optimised chassis shape • Made of laminated wood and aluminium with precision CNC machined surface • All turntable feet are fine adjustable • Optical Speed Control (OSC) • IMS – Innovative Motor Suspension (Suspension design of the motor using 18 O-rings)
Speed options:	33 1/3, 45, 78rpm
Drive unit:	<ul style="list-style-type: none"> • High torque 24V DC motor with belt drive • Fully automatic self-calibration of the speed by a push of a button • Hybrid engine control: A high resolution 12 bit digital-to-analog converter (DAC) generates a motor reference voltage, which is fed into the purely analog motor control. Automatic compensation of friction and temperature changes on the platter bearings and belts. The speed remains in the perfect range at all times.
Bearing:	Clearaudio CMB ceramic magnetic bearing in main platter. Inverted bearing in lower drive platter.
Platter:	50mm / 1.97 inch main platter, made out of synthetic material with high-density and excellent dimension. // 15mm / 0.59 inch stability, precision CNC machined surface, solid stainless steel sub-platter, dynamically balanced.
Speed accuracy (measured):	± 0.05%
Power consumption:	Max. consumption: 5.0 watts Consumption in operation: 2.1 watts Off mode: 1.8 watts
Total weight:	approx. 22kg (without tonearm and power supply)
Dimensions (W/D/H):	Approx. 495 x 343 x 180mm (with tonarm base, without tonearm)
Dimensions (W/D/H):	Approx. 19.49 x 13.50 x 7.09 inches (with tonarm base, without tonearm)
Manufacturer warranty:	5 years*

* Provided that the warranty card is correctly completed and returned to **Clearaudio**, or your product is registered online at <https://clearaudio.de/en/service/registration.php>, within 14 days of purchase.



Loving music

User manual

The full, extended warranty period for the *Reference Jubilee* turntable is 5 years.

To receive this full **Clearaudio** warranty, you must either complete and return the relevant section of the warranty registration card to **Clearaudio**, or register your product online at <https://clearaudio.de/en/service/registration.php>, within 14 days of purchase.

Otherwise only the legal warranty can be considered.

The full 5 year warranty can only be honoured if the product is returned in its original packing.

ENGLISH WARRANTY

For warranty information, contact your local **Clearaudio** distributor.

RETAIN YOUR PURCHASE RECEIPT

Your purchase receipt is your permanent record of a valuable purchase. It should be kept in a safe place to be referred to as necessary for insurance purposes or when corresponding with **Clearaudio**.

IMPORTANT

When seeking warranty service, it is the responsibility of the consumer to establish proof and date of purchase.

Your purchase receipt or invoice is adequate for such proof.

FOR U.K. ONLY

This undertaking is in addition to a consumer's statutory rights and does not affect those rights in any way.

FRANÇAIS GARANTIE

Pour des informations sur la garantie, contacter le distributeur local **Clearaudio**.

CONSERVER L'ATTESTATION D'ACHAT

L'attestation d'achat est la preuve permanente d'un achat de valeur. La conserver en lieu sûr pour s'y reporter aux fins d'obtention d'une couverture d'assurance ou dans le cadre de correspondances avec **Clearaudio**.

IMPORTANT

Pour l'obtention d'un service couvert par la garantie, il incombe au client d'établir la preuve de l'achat et d'en corroborer la date. Le reçu ou la facture constituent des preuves suffisantes.

DEUTSCH GARANTIE

Bei Garantiefragen wenden Sie sich bitte zunächst an Ihren **Clearaudio** Händler. Heben Sie Ihren Kaufbeleg gut auf.

WICHTIG!

Die Angaben auf Ihrer Quittung erlauben uns die Identifizierung Ihres Gerätes und belegen mit dem Kaufdatum die Dauer Ihrer Garantie-Ansprüche. Für Serviceleistungen benötigen wir stets die Gerätenummer. Diese finden Sie auf dem Typenschild auf der Rückseite des Gerätes oder auch in der beigelegten Garantie-Registrierkarte.

NEDERLANDS GARANTIE

Voor inlichtingen omtrent garantie dient u zich tot uw plaatselijke **Clearaudio**.

UW KWITANTIE, KASSABON E.D. BEWAREN

Uw kwitantie, kassabon e.d. vormen uw bewijs van aankoop van een waardevol artikel en dienen op een veilige plaats bewaard te worden voor evt, verwijzing bijv, in verbend met verzekering of bij correspondentie met **Clearaudio**.

BELANGRIJK

Bij een evt, beroep op de garantie is het de verantwoordelijkheid van de consument een gedateerd bewijs van aankoop te tonen. Uw kassabon of factuur zijn voldoende bewijs.

ITALIANO GARANZIA

L'apparecchio è coperto da una garanzia di buon funzionamento della durata di un anno, o del periodo previsto dalla legge, a partire dalla data di acquisto comprovata da un documento attestante il nominativo del Rivenditore e la data di vendita. La garanzia sarà prestata con la sostituzione o la riparazione gratuita delle parti difettose. Non sono coperti da garanzia difetti derivanti da uso improprio, errata installazione, manutenzione effettuata da personale non autorizzato o, comunque, da circostanze che non possano riferirsi a difetti di funzionamento dell'apparecchio. Sono inoltre esclusi dalla garanzia gli interventi inerenti l'installazione e l'allacciamento agli impianti di alimentazione.

Gli apparecchi verranno riparati presso i nostri Centri di Assistenza Autorizzati. Le spese ed i rischi di trasporto sono a carico del cliente. La casa costruttrice declina ogni responsabilità per danni diretti o indiretti provocati dalla inosservanza delle prescrizioni di installazione, uso e manutenzione dettagliate nel presente manuale o per guasti dovuti ad uso continuato a fini professionali.

ESPAÑOL GARANZIA

Para obtener información acerca de la garantía póngase en contacto con su distribuidor **Clearaudio**.

GUARDE SU RECIBO DE COMPRA

Su recibo de compra es su prueba permanente de haber adquirido un aparato de valor, Este recibo deberá guardarlo en un lugar seguro y utilizarlo como referencia cuando tenga que hacer uso del seguro o se ponga en contacto con **Clearaudio**.

IMPORTANTE

Cuando solicite el servicio otorgado por la garantía el usuario tiene la responsabilidad de demostrar cuándo efectuó la compra. En este caso, su recibo de compra será la prueba apropiada.





Loving music

clearaudio electronic GmbH

Spardorfer Straße 150
91054 Erlangen
Germany

Phone/Tel.: +49 9131 40300 100

Fax: +49 9131 40300 119

www.clearaudio.de

www.analogshop.de

info@clearaudio.de



Handmade in Germany

Clearaudio Electronic accepts no liability for any misprints.

Technical specifications are subject to change or improvement without prior notice.

Product availability is as long as stock lasts.

Copies and reprints of this document, including extracts, require written consent from

Clearaudio Electronic GmbH, Germany.

2024