



Loving music

# Innovation Compact

---

**User manual**  
**Innovation Compact and**  
**Innovation Compact Wood**



**Innovation Compact**



**Innovation Compact Wood**

**Innovation Compact**  
**Figures: package with**  
**clearaudio tonearm „Universal“**  
**and clearaudio cartridge „da**  
**Vinci“.**

---

Hi-Fi Components **clearaudio electronic**<sup>®</sup> GmbH

Spardorfer Str. 150 ● D-91054 Erlangen ● Tel. +49(0) 1805/059595 ● FAX +49(0) 09131/51683  
[www.clearaudio.de](http://www.clearaudio.de) ● [www.analogshop.de](http://www.analogshop.de) ● [info@clearaudio.de](mailto:info@clearaudio.de) ● copyright clearaudio©2010



# ***Innovation Compact***

User manual

Dear **clearaudio** customer,

Congratulations to your choice of the *Innovation-Compact* turntable, a world class turntable, handmade in Germany by **clearaudio** electronic GmbH.

Resonance minimizing chassis sandwich construction in combination with the innovative motor unit (low noise level and high turning moments), guarantees total isolation of resonances from the turntable chassis, providing the best music reproduction and authentic High End imaging. A high precision, maintenance free sinter bronze bearing is completing the analogue pleasure.

The **clearaudio** patented CMB-Bearing-Technology, an inverted bearing with jewelled and polished ceramic bearing shaft and a bronzed liner, provides frictionless analog enjoyment.

Please read this instruction manual carefully, to avoid any damages or loss of warranty. This manual will help you for an easy set-up and guarantees the highest pleasure for a long time.

We wish you a lot of musical enjoyments with your new **clearaudio** *Innovation Compact*-turntable.

**clearaudio** electronic GmbH

This section must be read before any connection is made to the mains supply.

## **WARNINGS**

- Don't expose your turntable to rain or humidity.
- Don't handle the mains leads with wet hands.
- Don't place or insert anything into the equipment or through ventilation holes.
- No naked flame sources, such as lighted candles, should be placed on the equipment.

## **CE-MARKING**

**CE** The **clearaudio** *Innovation Compact* meets the regulations concerning electromagnetic disturbance (EMC) and low-voltage appliances.

## **EQUIPMENT MAINS WORKING SETTING**

Your clearaudio product has been prepared to comply with the household power and safety requirements that exist in your area. This product can be connected to 230 V or 110 V AC (50 Hz and 60 Hz).

## **COPYRIGHT**

Recording und reproduction of any sound-material may require the consent of the creator. Please acknowledge the information given in the

- Copyright Act 1956,
- Dramatic and Musical Performers Act 1958,
- Performers Protection Acts 1963 and 1072,
- any more recent legal regulations.

## **Contents**

<b>1. Packing overview</b>	<b>3</b>
<b>2. Part list</b>	<b>4</b>
<b>3. Installation and set up</b>	<b>6</b>
<b>4 Fine adjustment of the motor</b>	<b>10</b>
<b>5. Service and special instruction</b>	<b>11</b>
<b>6. Technical data</b>	<b>12</b>
<b>Warranty information</b>	<b>13</b>

## 1. Packing overview

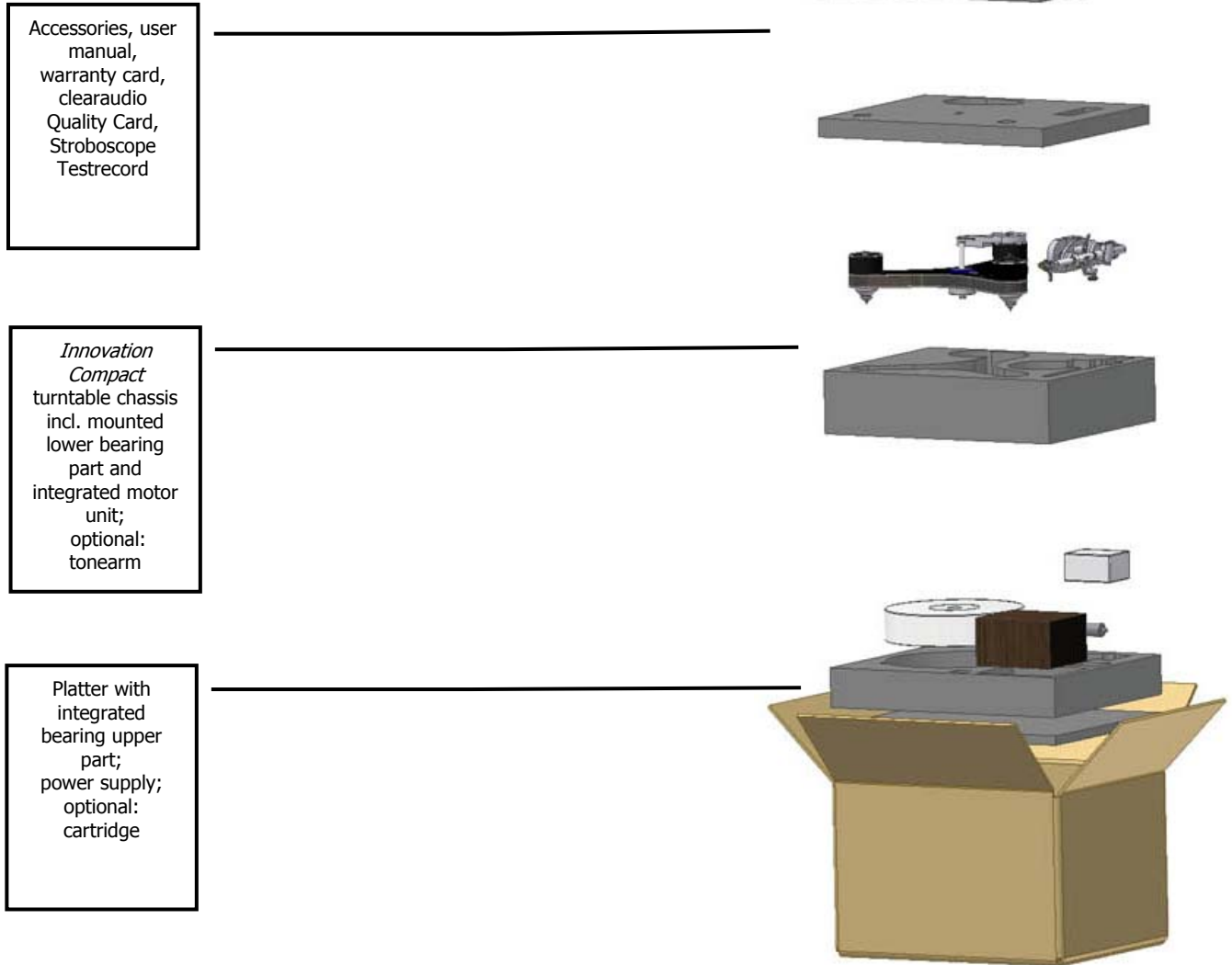

**Pic. 1:** Packing overview

## 2. Part list

**Clearaudio** has developed a special and secure packing for your *Innovation Compact*-turntable that ensures a safe transportation.

Please keep this original packing, if you need to ship the turntable.

Below you find the part list of the **clearaudio** *Innovation Compact*-turntable:

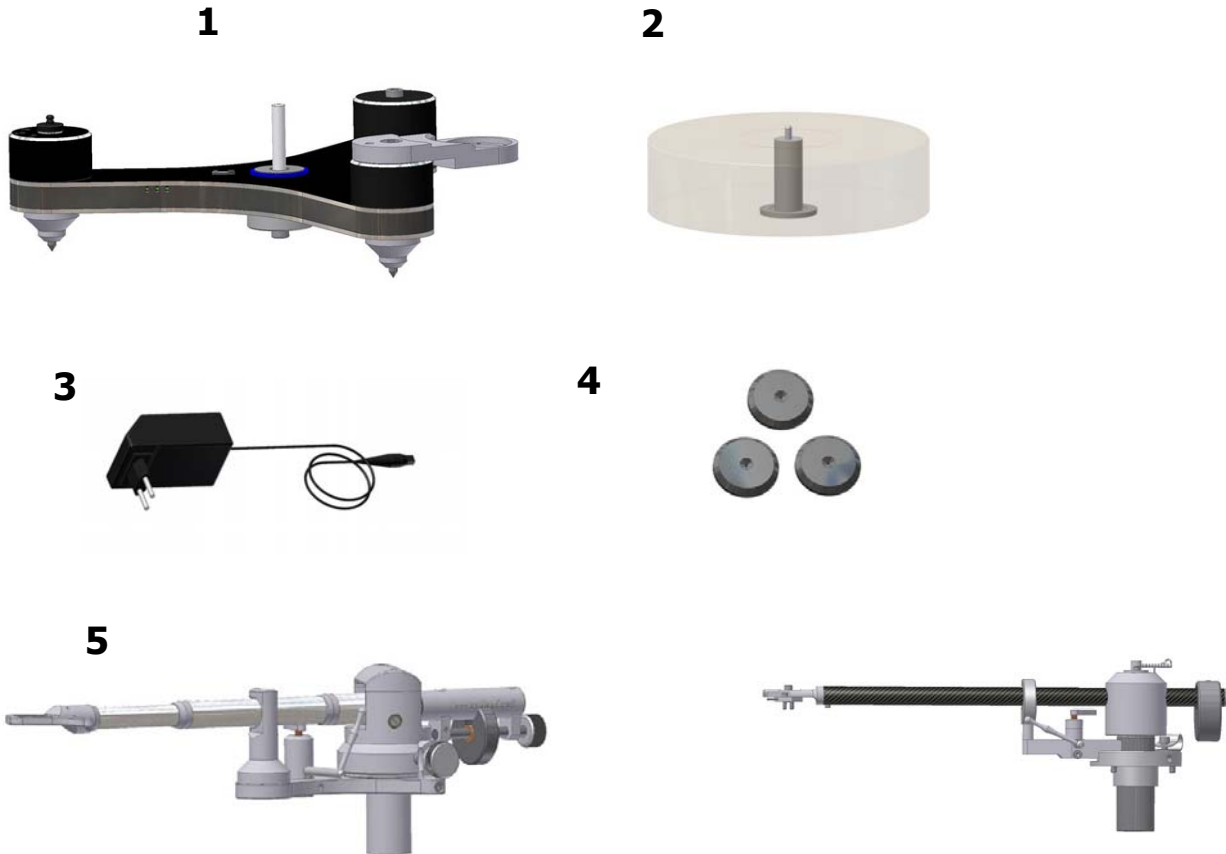

**Figure 5 a:**  
clearaudio Universal tonearm

**Figure 5 b:**  
clearaudio Unify tonearm

1.	Turntable body with mounted lower bearing part	2.	Platter with integrated upper bearing part
3.	power supply	4.	3 x Flat Pads
5.	Optional: <b>clearaudio</b> <i>Universal</i> (Fig. 5 a) or <i>Unify 9"</i> (Fig. 5 b) tonearm Optional: 30 mm base for <i>Universal</i> tonearm (not shown)		

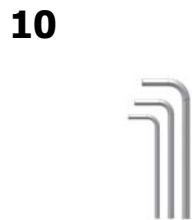
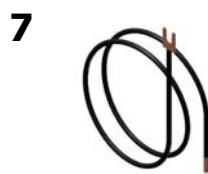

6.	1 Pair of white gloves	7.	Grounding - wire for the <i>Innovation</i> -turntable (to connect in the bottom bearing part)
8.	Level gauge for the turntable alignment	9.	2 pcs. drive belts
10.	3 pcs. allen – keys; sizes: # 2 (optional: Universal Tonearm: # 3 / # 7)	11.	Aluminium precision screw driver
12.	Bearing oil for occasional use	13.	<b>clearaudio</b> Stroboscope Testrecord (Art. No. AC038) to adjust the exact speed
14.	Optional in package: <b>clearaudio</b> MC cartridge	15.	Optional in package: Turntable + tonearm + cartridge No illustration: cartridge alignment gauge for <i>Unify</i> or <i>Universal</i> -tonearm (optional)
16.	Not shown: warranty card, <b>clearaudio</b> Quality certificate card	17.	Not shown: User Manual

## 3. Installation and set up

The set up of the *Innovation Compact* turntable is easy as the turntable chassis is pre-assembled and has been tested at the factory. Please use the white gloves enclosed in order to avoid scratches or unwanted fingerprints (platter).

The *Innovation Compact* turntable requires a space for set-up of at least 18,90 inch x 19,29 inch.

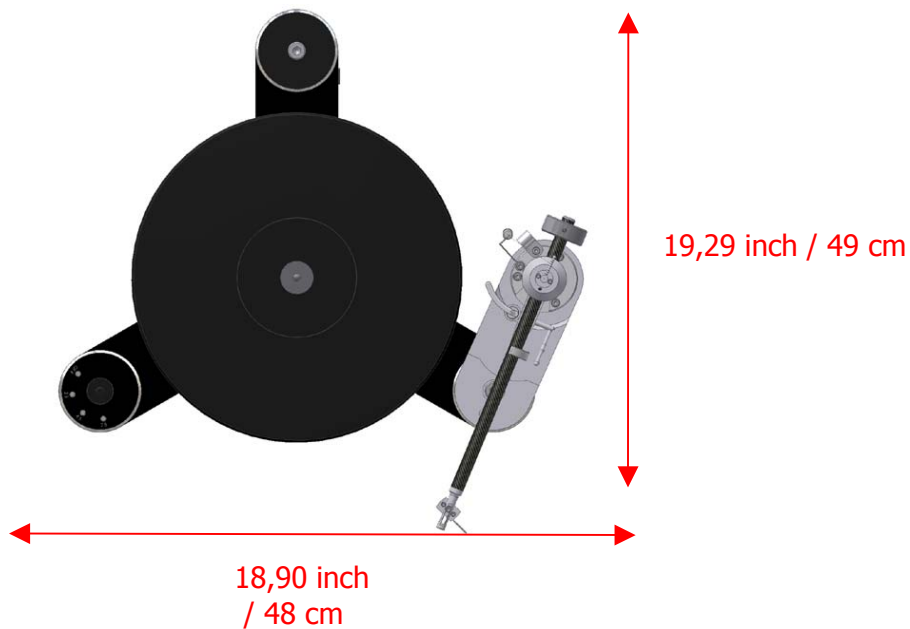

**Pic. 2:** Required set - up space

**Please follow the description step by step:**

**1.)**

First take out the three black flat pads out of the accessory bag. Place these flat pads on your hifi-rack or another suitable base, where the final position of your *Innovation Compact* – turntable will be.

**2.)**

After that, take the *Innovation Compact*-turntable body of the next packing layer. and place the spikes of the turntable on the flat pads.



**Pic. 3:** Innovation with tonearm base

**3.)**

Remove the protective security tape from the bearing housing. Place two drops of the synthetic bearing oil on the ceramic bearing shaft (also available at [www.analogshop.de](http://www.analogshop.de)).

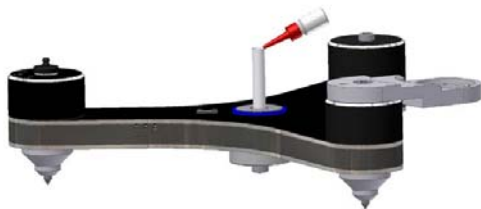

**Pic. 4:** Oiling the bearing shaft

## 4.)

In the next step remove the lamination of the sensor, mounted on the turntable chassis (picture 5: red frame).

**Please remove the lamination extreme carefully and avoid any soiling and scratches.**



**Pic. 5:** Removing the lamination

## 5.)

### 5.1.

Take the platter with both hands (with white gloves) carefully out of the packing.

**Please pay attention that the integrated bearing does not fall out of the platter!**

The flat side of the platter should face to the chassis and the side with the cut-out (for the record) should face up.

### 5.2.

In the next step remove the lamination of the sensor on the bottom side of the platter.

**Please remove the lamination extreme carefully and avoid any soiling and scratches.**

### 5.3.

With both hands you can place the platter carefully onto the bearing.

Through a lightly (!! ) up and down movement the platter will slip onto the bearing upper part (picture 6).

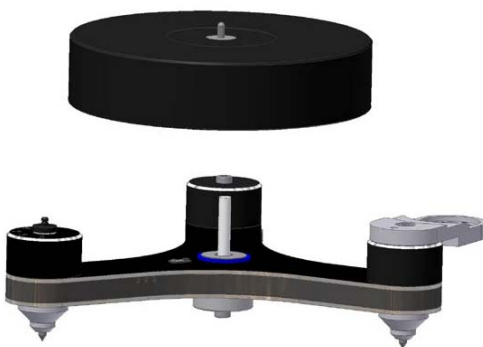

**Avoid major side forces to prevent any damages to the ceramic bearing!**

To avoid any damages on your bearing, the platter should have room temperature before the set up begin (approx. 20 ° Celsius).

**Pic. 6:** To set up the platter

Make sure with gentle pressure that the platter is applying on the complete surface of the bearing.

## 6.)

To install the tonearm and / or to mount and adjust a cartridge, please follow the user manual of the manufacturer.

## 7.)

**The following final adjustment is very important:**

**Please ensure that your turntable rack is in a levelled position.**

Please check with the delivered level gauge, if your *Innovation Compact* turntable is in a levelled position.

You can adjust each of the turntables` feet to get the turntable levelled.

To adjust the height, first turn the middle part of the feet (Pic. 8 a; green arrow), then you can twist the end part (Pic 8 b, red frame) to the desired height.

After the adjustment, please make sure, to turn the middle part again to fix the selected position.



**Pic. 7:** Alignment of the turntable

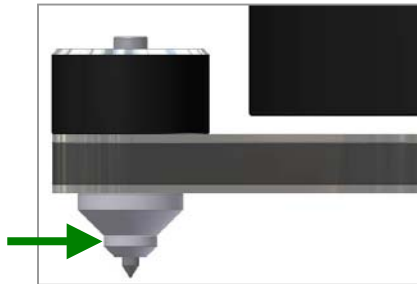

**Pic. 8 a:** Middle part

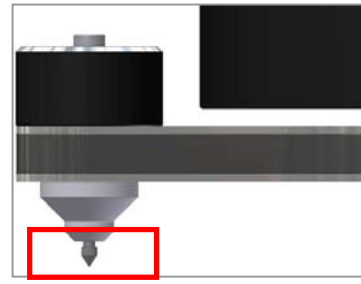

**Pic. 8 b:** End part

Only if the turntable is in a levelled position you will get the best results with your *Innovation Compact* turntable.

## 8.)

Please connect the plug of the power supply with the linkage of the turntable. After that connect the power supply with the electric power supply.

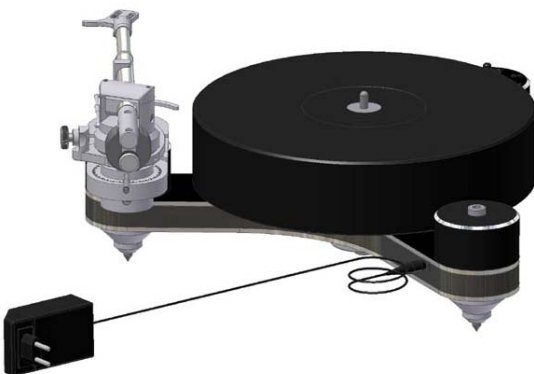

**Pic. 9:** Connection of power supply and motor

## 9.)

Place the drive belt around the platter and around the motor pulley.

By pushing the sensor-switch, marked with "33 1/3" on the motor, the turntable starts to spin until 33 1/3 rpm is reached.

After the initial set-up we recommend to let the turntable spin for at least 15 to 30 minutes. This ensures a smoother break in.

## 4. Fine adjustment of the *Innovation Compact* motor

### 1.)

The motor adjustment is already pre set at the factory. Through the transport some small speed deviations can occur. Please check the speed before using the turntable for the first time.

For the correct adjustment of the speed please put the recommended **clearaudio** Stroboscope Testrecord on the platter. Follow hereby the instruction of the Stroboscope Testrecord user manual. To check the speed with highest accuracy please use the **clearaudio** Speed Light (AC039) ([www.analogshop.de](http://www.analogshop.de)).

On the front side of your turntable there are three setting trimmers (see pic. 10).



- left trimmer = setting 33 1/3 rpm  
(near turntable motor)
- middle trimmer = setting 45 rpm
- right trimmer = setting 78 rpm  
(near turntable bearing)

**Pic. 10:** Fine adjustment of the motor (on the frontside)

If you like to adjust the speed 33 1/3 rpm , take the aluminium screw driver (see accessories) and turn the left trimmer until you have reached the right speed according to the Stroboscope Testrecord (see user manual "Stroboscope Testrecord").

- Turning the trimmer counter clockwise = reduces the turntable speed
- Turning the trimmer clockwise = raises the turntable speed

Please proceed with the speed adjustment for 45 rpm and 78 rpm in the same way!

### **Please note:**

If the turntable does not reach the correct speed, the sensor or the scale ring could be dirty or dusty.

To clean the sensor, please take off the platter very carefully !

Clean the sensor and the scale ring with a little isopropyl alcohol and a cotton bud.

Be careful and avoid any scratches on the sensor or the scale ring!

If the motor has further more speed variations please contact your nearest authorized **clearaudio** dealer or directly the **clearaudio** factory (address on page 11).

Now you are finally ready to play your vinyl records.

We wish you a lot of pleasure with your new *Innovation Compact*-turntable.

## 5. Service and special instruction

In case of any necessary, service for all **clearaudio** products should be done by authorized personal only.

In case of any repair, the clearaudio *Innovation Compact*-turntable needs to be send to your nearest authorized **clearaudio** distributor, dealer or directly to the **clearaudio** factory.

clearaudio electronic GmbH  
Spardorfer Str 150  
91054 Erlangen  
Germany  
Tel/Phone: +49-(0)9131/59595  
[www.clearaudio.de](http://www.clearaudio.de)  
[www.analogshop.de](http://www.analogshop.de)  
[info@clearaudio.de](mailto:info@clearaudio.de)

Send / ship the *Innovation Compact* -turntable always and only in the original packing !!!

Only in the original packing **clearaudio** can provide the warranty.

If you repackage the turntable, please make all steps inverted like at installation and set up (chapter 3).

### 5.1 Special instruction

To achieve the full **clearaudio** warranty (for the *Innovation Compact* turntable 5 years), it is necessary that you fill out and send the **corresponding part of the warranty registration card back to clearaudio**, within two weeks after purchase.

Only if the product is returned in it's original packing **clearaudio** can provide the warranty.

#### Transportation advice:

If any transportation of the *Innovation Compact*-turntable should be necessary, please always remove the turntable platter and the shaft holder. Otherwise serious damage can occur!

To avoid any dust coming into the bearing, the bearing hole needs to be covered as well.

If the *Innovation Compact* -turntable is a longer time not in use, please disconnect the motor from the main supply.

Every two years you can lubricate the bearing of the turntable platter with the delivered oil. In this case it is enough to put 4 or 5 drops of the oil into bearing.

Please take special caution to any damages of the power cord. Any damages should be repaired only by authorized personal.

A damaged power cord must be exchanged immediately!

#### Caution !

**Please use only non alcoholic fluids and only fluids specially used for acrylic, to clean the *Innovation Compact*-turntable.**

Otherwise damage on the material or the surface can occur!

Don't use try cloths for cleaning because of the electrostatic charging. Suitable cleaning fluids will be available at **clearaudio** ([www.analogshop.de](http://www.analogshop.de)) or your Hifi dealer.

## 6. Technical data

<b>Construction principle:</b>	Resonance optimised chassis's shape, belt driven with optical, full automatic speed control
<b>Speed possibilities:</b>	33 1/3 rpm / 45 rpm / 78 rpm
<b>Drive unit:</b>	Decoupled DC motor in a massive metal-housing. This <i>Innovation Compact</i> can be connected to 230 V or 110 V AC (50 Hz and 60 Hz).
<b>Bearing:</b>	Inverted and polished ceramic bearing shaft, polished sinter bronze insert, including patented CMB bearing technology
<b>Platter:</b>	Delrin or acrylic GS-PMMA platter (Wood version), precision CNC machined surface
<b>Speed variation less than:</b>	±0,08 %
<b>Deviance of the set value</b>	±0,01 %
<b>Weight</b>	approx. 12 kg (without tonearm and power supply)
<b>Dimensions:</b>	approx. 479 mm x 485 mm x 141 mm (18,86 inch x 19,09 inch x 5,55 inch)
<b>Warranty:</b>	5 years* (see page 13)

\* Only if the warranty card is filled out correctly and sent back to **clearaudio!**

**Clearaudio** electronic is not responsible for typographical errors in descriptions. Technical specifications subject to change or improvement without prior notice. Availability as long as stock lasts. Copies and imprints- also only in extracts – require written conformation through **clearaudio** electronic GmbH; Germany



To achieve the full **clearaudio** warranty (*Innovation Compact* turntable 5 years), it is necessary that you fill out and send the corresponding part of the warranty registration certificate /card back to **clearaudio**, within two weeks after purchase. Only if the product is returned in it's original packing **clearaudio** can provide the warranty of 5 years.

## **ENGLISH** **WARRANTY**

For warranty information, contact your local clearaudio distributor.

### **RETAIN YOUR PURCHASE RECEIPT**

Your purchase receipt is your permanent record of a valuable purchase.

It should be kept in a safe place to be referred to as necessary for insurance purposes or when corresponding with clearaudio.

### **IMPORTANT**

When seeking warranty service, it is the responsibility of the consumer to establish proof and date of purchase. Your purchase receipt or invoice is adequate for such proof.

### **FOR U.K. ONLY**

This undertaking is in addition to a consumer's statutory rights and does not affect those rights in any way.

## **FRANCAIS**

### **GARANTIE**

Pour des informations sur la garantie, contacter le distributeur local clearaudio.

### **CONSERVER L'ATTESTATION D'ACHAT**

L'attestation d'achat est la preuve permanente d'un achat de valeur. La conserver en lieu sûr pour s'y reporter aux fins d'obtention d'une couverture d'assurance ou dans le cadre de correspondances avec clearaudio.

### **IMPORTANT**

Pour l'obtention d'un service couvert par la garantie, il incombe au client d'établir la preuve de l'achat et d'en corroborer la date. Le reçu ou la facture constituent des preuves suffisantes.

## **DEUTSCH**

### **GARANTIE**

Bei Garantiefragen wenden Sie sich bitte zunächst an Ihren clearaudio-Händler.

Heben Sie Ihren Kaufbeleg gut auf.

### **WICHTIG!**

Die Angaben auf Ihrer Quittung erlauben uns die Identifizierung Ihres Gerätes und belegen mit dem Kaufdatum die Dauer Ihrer Garantie-Ansprüche.

Für Serviceleistungen benötigen wir stets die Gerätenummer.

Diese finden Sie auf dem Typenschild auf der Rückseite des Gerätes oder auch in der beigelegten Garantie-Registrierkarte.

## **NEDERLANDS**

### **GARANTIE**

Voor inlichtingen omtrent garantie dient u zich tot uw plaatselijke clearaudio.

### **UW KWITANTIE, KASSABON E.D. BEWAREN**

Uw kwitantie, kassabon e.d. vormen uw bewijs van aankoop van een waardevol artikel en dienen op een veilige plaats bewaard te worden voor evt, verwijzing bijv, in verband met verzekering of bij correspondentie met clearaudio.

### **BELANGRIJK**

Bij een evt, beroep op de garantie is het de verantwoordelijkheid van de consument een gedateerd bewijs van aankoop te tonen. Uw kassabon of factuur zijn voldoende bewijs.

## **ITALIANO**

### **GARANZIA**

L'apparecchio è coperto da una garanzia di buon funzionamento della durata di un anno, o del periodo previsto dalla legge, a partire dalla data di acquisto comprovata da un documento attestante il nominativo del Rivenditore e la data di vendita. La garanzia sarà prestata con la sostituzione o la riparazione gratuita delle parti difettose.

Non sono coperti da garanzia difetti derivanti da uso improprio, errata installazione, manutenzione effettuata da personale non autorizzato o, comunque, da circostanze che non possano riferirsi a difetti di funzionamento dell'apparecchio. Sono inoltre esclusi dalla garanzia gli interventi inerenti l'installazione e l'allacciamento agli impianti di alimentazione.

Gli apparecchi verranno riparati presso i nostri Centri di Assistenza Autorizzati. Le spese ed i rischi di trasporto sono a carico del cliente. La casa costruttrice declina ogni responsabilità per danni diretti o indiretti provocati dalla inosservanza delle prescrizioni di installazione, uso e manutenzione dettagliate nel presente manuale o per guasti dovuti ad uso continuato a fini professionali.

## **ESPAÑOL**

### **GARANTIA**

Para obtener información acerca de la garantía póngase en contacto con su distribuidor clearaudio.

### **GUARDE SU RECIBO DE COMPRA**

Su recibo de compra es su prueba permanente de haber adquirido un aparato de valor, Este recibo deberá guardarlo en un lugar seguro y utilizarlo como referencia cuando tenga que hacer uso del seguro o se ponga en contacto con clearaudio.

### **IMPORTANTE**

Cuando solicite el servicio otorgado por la garantía el usuario tiene la responsabilidad de demostrar cuándo efectuó la compra. En este caso, su recibo de compra será la prueba apropiada.